

A+/-0.01	B+/-0.01	C+/-0.01	T+/-0.0008
0.096	0.437	0.065	0.010

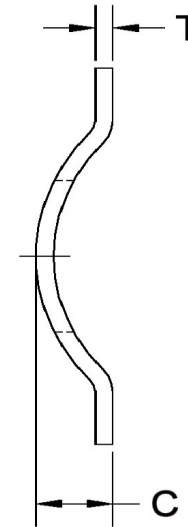

Dimensions in Inches

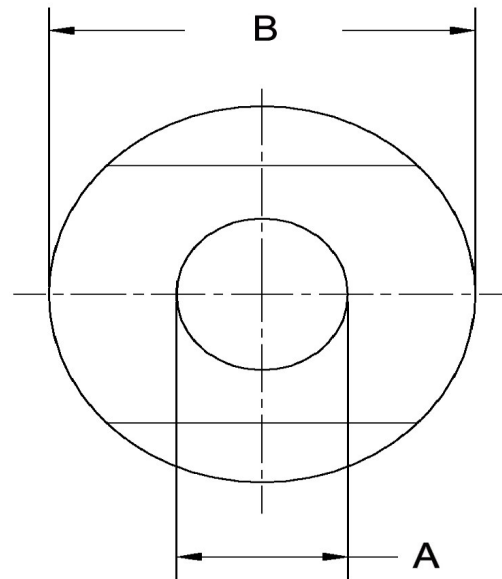

SEASTROM MANUFACTURING CO., INC.
 456 SEASTROM STREET
 TWIN FALLS, IDAHO 83301
 (208) 737-4300 FAX (208) 734-7222

ALL INFORMATION
 COPYRIGHTED BY
 SEASTROM MFG. ©

PART NO.:	5807-1-2
PART NAME:	Washers, Spring, Single Wave
MATERIAL:	Spring Steel
HEAT TREAT:	Please refer to Material & Finish Specifications in Engineering Resources
FINISH:	None