

A+/-0.01	B+/-0.01	C+/-0.01	T+/-0.001
0.096	0.437	0.065	0.010

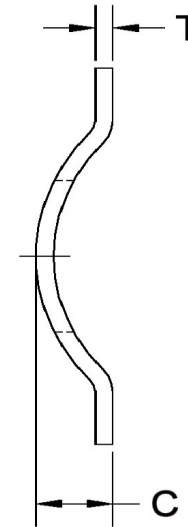

Dimensions in Inches

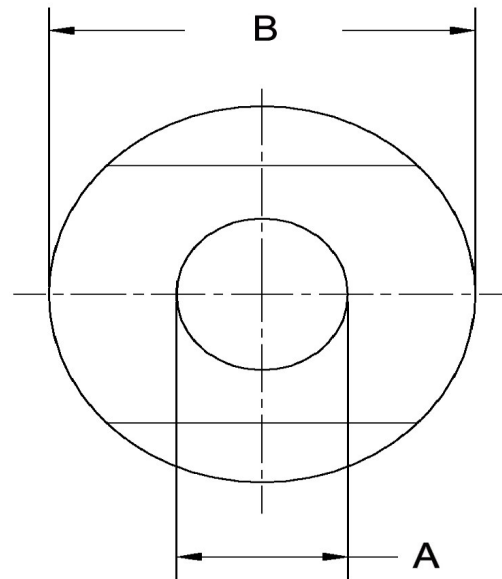

SEASTROM MANUFACTURING CO., INC.  
 456 SEASTROM STREET  
 TWIN FALLS, IDAHO 83301  
 (208) 737-4300 FAX (208) 734-7222

ALL INFORMATION  
 COPYRIGHTED BY  
 SEASTROM MFG. ©

<b>PART NO.:</b>	5807-1-1
<b>PART NAME:</b>	Washers, Spring, Single Wave
<b>MATERIAL:</b>	Beryllium Copper
<b>HEAT TREAT:</b>	Please refer to Material & Finish Specifications in Engineering Resources
<b>FINISH:</b>	None