

A+/-0.005	B+/-0.01	C+/-0.01	D+/-0.005	T+/-0.0025
2.005	2.750	0.193	0.505	0.020

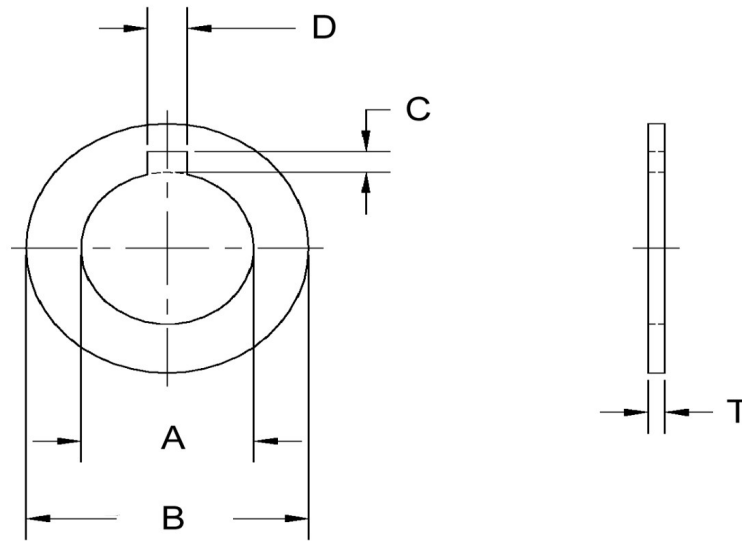

Dimensions in Inches



SEASTROM MANUFACTURING CO., INC.
 456 SEASTROM STREET
 TWIN FALLS, IDAHO 83301
 (208) 737-4300 FAX (208) 734-7222

ALL INFORMATION
 COPYRIGHTED BY
 SEASTROM MFG. ©

PART NO.:	5752-8-20
PART NAME:	Washers, Tab,Key-ch, Single Internal Notch
MATERIAL:	Stainless Steel 301-304
HEAT TREAT:	Please refer to Material & Finish Specifications in Engineering Resources
FINISH:	None