

A+/- .005	B+/- .01	C+/- .01	D+/- .005	T+/- .0008
1.255	1.750	0.130	0.317	0.008

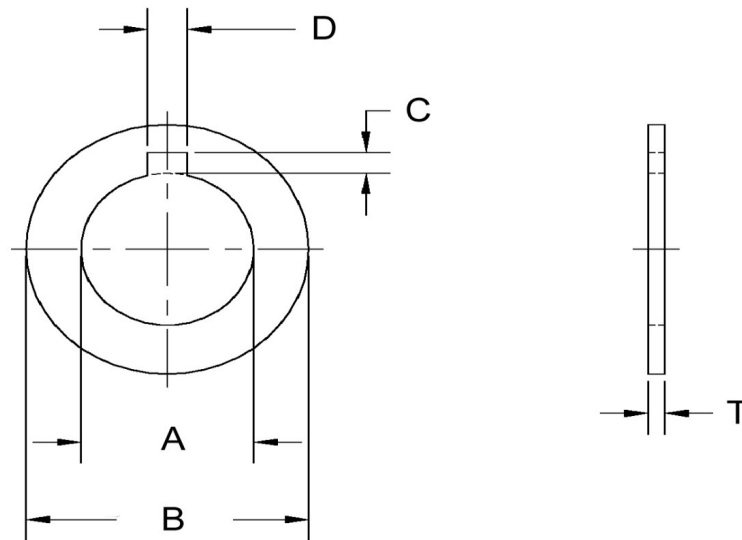

SEASTROM MANUFACTURING CO., INC.
 456 SEASTROM STREET
 TWIN FALLS, IDAHO 83301
 (208) 737-4300 FAX (208) 734-7222

ALL INFORMATION
 COPYRIGHTED BY
 SEASTROM MFG. ©

PART NO.:	5752-6-8
PART NAME:	Washers, Tab, Key-ch, Single Internal Notch
MATERIAL:	Stainless Steel 301-304
HEAT TREAT:	Please refer to Material & Finish Specifications in Engineering Resources
FINISH:	None

Dimensions in Inches