

A+/-0.005	B+/-0.01	C+/-0.01	D+/-0.005	T+/-0.005
1.005	1.500	0.099	0.255	0.093

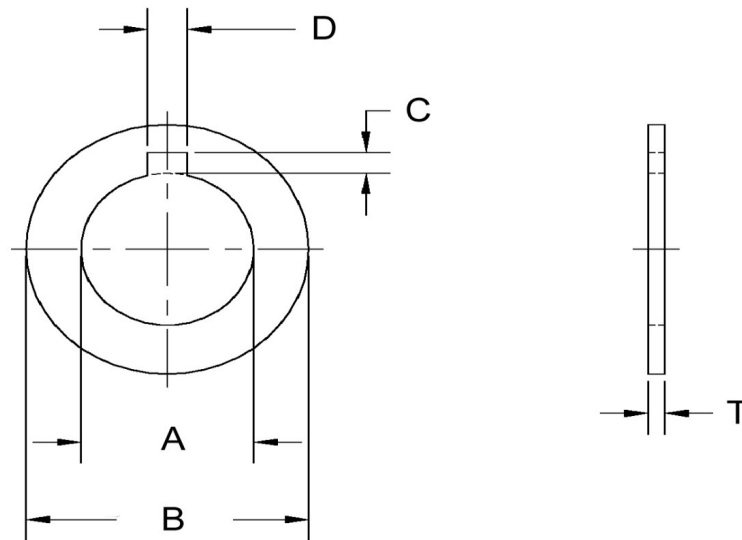

Dimensions in Inches



SEASTROM MANUFACTURING CO., INC.  
 456 SEASTROM STREET  
 TWIN FALLS, IDAHO 83301  
 (208) 737-4300 FAX (208) 734-7222

ALL INFORMATION  
 COPYRIGHTED BY  
 SEASTROM MFG. ©

<b>PART NO.:</b>	5752-5-90
<b>PART NAME:</b>	Washers, Tab,Key-ch, Single Internal Notch
<b>MATERIAL:</b>	Stainless Steel 301-304
<b>HEAT TREAT:</b>	Please refer to Material & Finish Specifications in Engineering Resources
<b>FINISH:</b>	None