

A+/-0.005	D°+/-2	B+/-0.01	T+/-0.0025	Screw Size
0.172	100	0.332	0.016	8

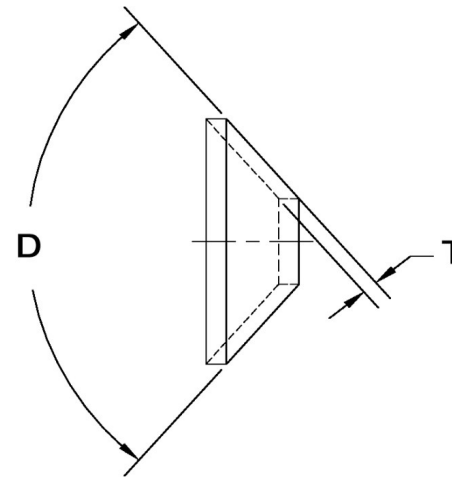

Dimensions in Inches

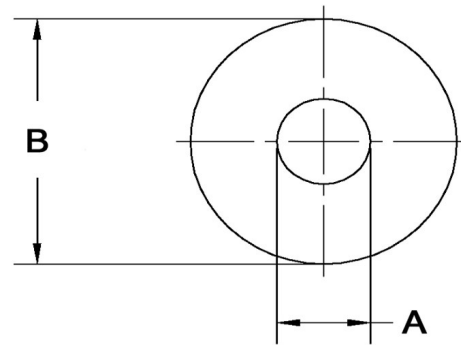

SEASTROM MANUFACTURING CO., INC.  
 456 SEASTROM STREET  
 TWIN FALLS, IDAHO 83301  
 (208) 737-4300 FAX (208) 734-7222

ALL INFORMATION  
 COPYRIGHTED BY  
 SEASTROM MFG. ©

<b>PART NO.:</b>	5736-20
<b>PART NAME:</b>	Washers, Counter Sunk2
<b>MATERIAL:</b>	Aluminum
<b>HEAT TREAT:</b>	Please refer to Material & Finish Specifications in Engineering Resources
<b>FINISH:</b>	None