

A+/-0.005	D°+/-2	B+/-0.01	T+/-0.002	Screw Size
0.145	82	0.279	0.010	6

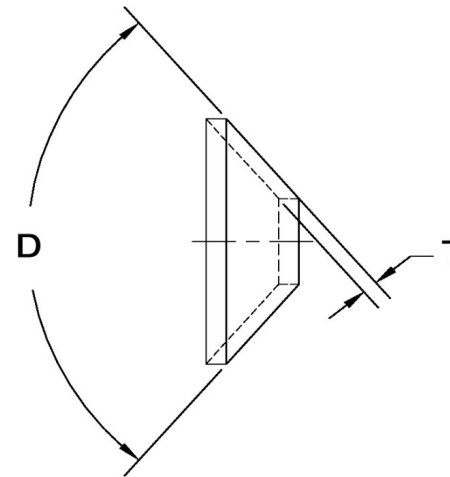

Dimensions in Inches

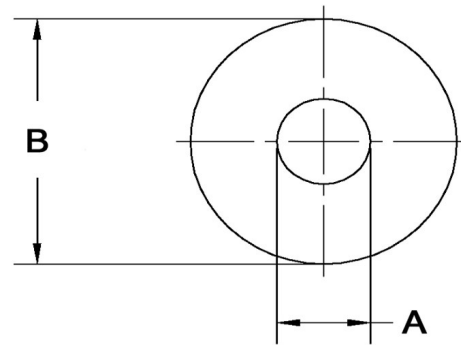

SEASTROM MANUFACTURING CO., INC.
 456 SEASTROM STREET
 TWIN FALLS, IDAHO 83301
 (208) 737-4300 FAX (208) 734-7222

ALL INFORMATION
 COPYRIGHTED BY
 SEASTROM MFG. ©

PART NO.:	5736-14
PART NAME:	Washers, Counter Sunk2
MATERIAL:	Aluminum
HEAT TREAT:	Please refer to Material & Finish Specifications in Engineering Resources
FINISH:	None