

STYLE	A+/-0.005	B+/-0.01	C+/-0.01	T+/-0.003	Screw Size
1	0.334	0.566	0.619	0.030	

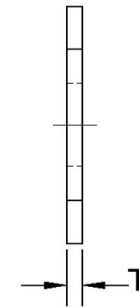

STYLE 1

Dimensions in Inches

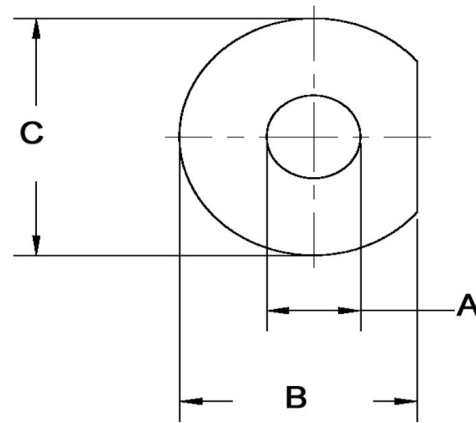

SEASTROM MANUFACTURING CO., INC.
 456 SEASTROM STREET
 TWIN FALLS, IDAHO 83301
 (208) 737-4300 FAX (208) 734-7222

ALL INFORMATION
 COPYRIGHTED BY
 SEASTROM MFG. ©

PART NO.:	5734-36
PART NAME:	Washers, D Shaped
MATERIAL:	Cold Rolled Steel
HEAT TREAT:	Please refer to Material & Finish Specifications in Engineering Resources
FINISH:	None