

B+/- .106	D+/- .005	L+/- .01	W+/- .01	H+/- .016	T+/- .003	Wire Size	Screw Size
0.125	0.171	0.875	0.500	0.160	0.018	12-20	8

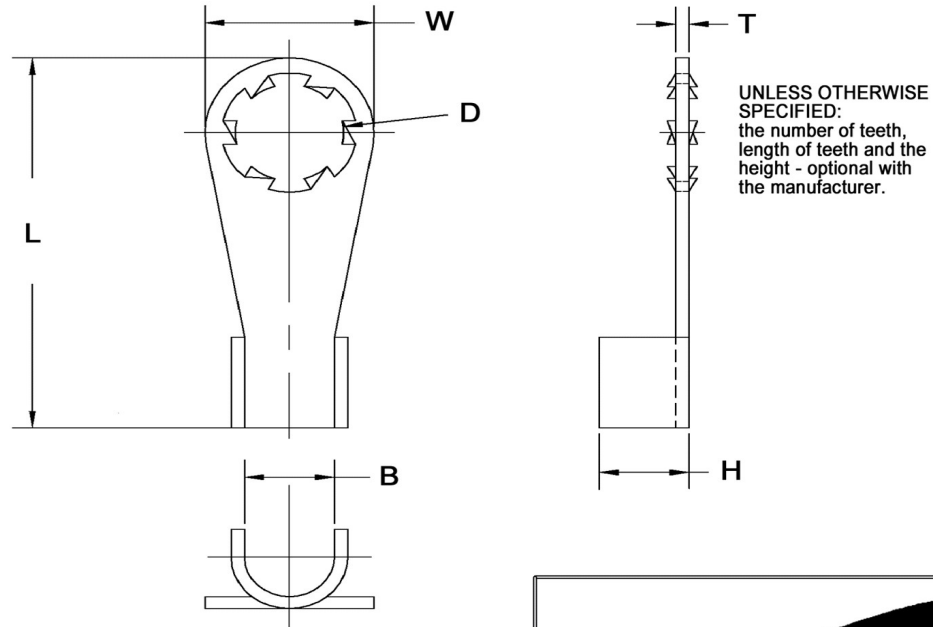

SEASTROM MANUFACTURING CO., INC.
456 SEASTROM STREET
TWIN FALLS, IDAHO 83301
(208) 737-4300 FAX (208) 734-7222

ALL INFORMATION
COPYRIGHTED BY
SEASTROM MFG. ©

PART NO.:	5465-1B
PART NAME:	Solder Lugs 2
MATERIAL:	Brass
HEAT TREAT:	Please refer to Material & Finish Specifications in Engineering Resources
FINISH:	Bright Tin (All Dimensions Are Prior To Plating)

Dimensions in Inches