

A (Rad)+/-0.01	B1+/-0.005	B2+/-0.005	C	D+/-0.01	E+/-0.02	F+/-0.01	G+/-0.016	T+/-0.003
0.187	0.180	0.260	1.438	0.290	0.375	0.375	0.375	0.030

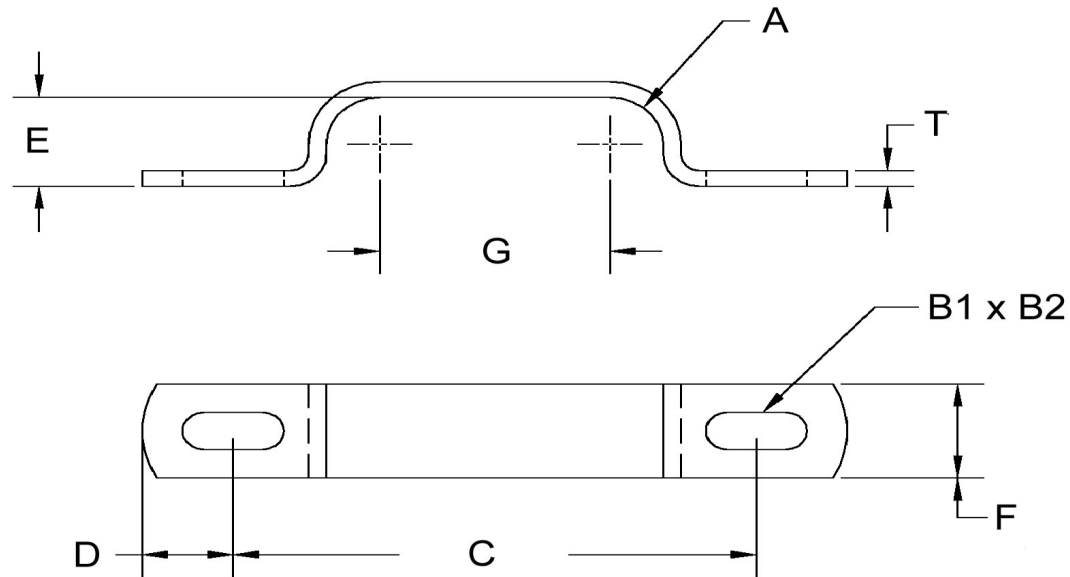

Dimensions in Inches



SEASTROM MANUFACTURING CO., INC.  
 456 SEASTROM STREET  
 TWIN FALLS, IDAHO 83301  
 (208) 737-4300 FAX (208) 734-7222

ALL INFORMATION  
 COPYRIGHTED BY  
 SEASTROM MFG. ©

<b>PART NO.:</b>	5310-7-Z3
<b>PART NAME:</b>	Clamps, Retaining
<b>MATERIAL:</b>	Cold Rolled Steel
<b>HEAT TREAT:</b>	Please refer to Material & Finish Specifications in Engineering Resources
<b>FINISH:</b>	Zinc Type III or V (All Dimensions Are Prior To Plating)