

A (Rad) \pm -.01	B1 \pm -.005	B2 \pm -.005	C	D \pm -.01	E \pm -.02	F \pm -.01	G \pm -.016	T \pm -.003
0.625	0.265	0.346	3.248	0.290	1.250	0.500	1.250	0.060

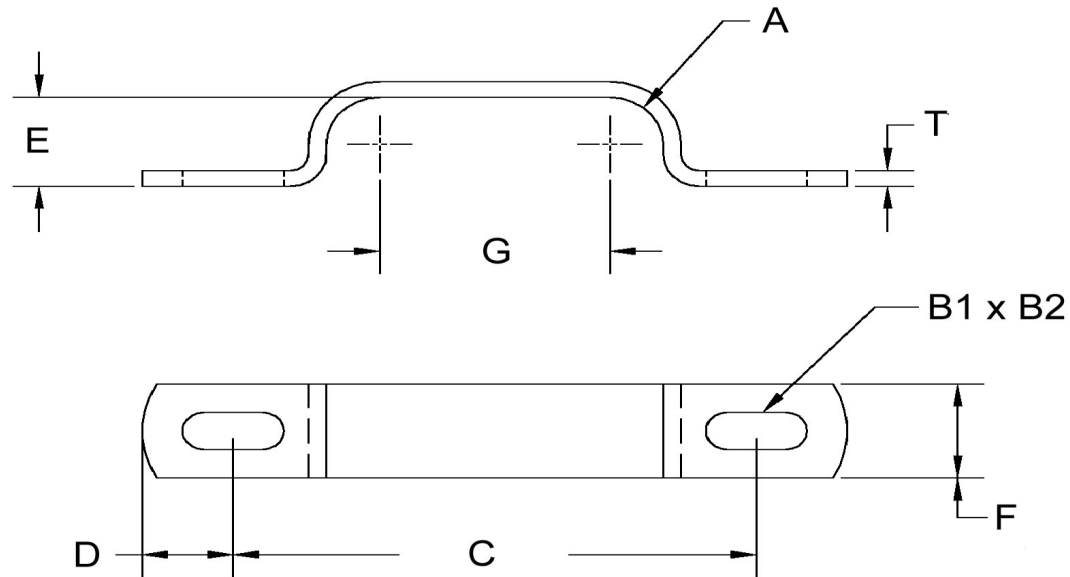

SEASTROM MANUFACTURING CO., INC.
 456 SEASTROM STREET
 TWIN FALLS, IDAHO 83301
 (208) 737-4300 FAX (208) 734-7222

ALL INFORMATION
 COPYRIGHTED BY
 SEASTROM MFG. ©

PART NO.:	5310-33
PART NAME:	Clamps, Retaining
MATERIAL:	Cold Rolled Steel
HEAT TREAT:	Please refer to Material & Finish Specifications in Engineering Resources
FINISH:	None

Dimensions in Inches