

A (Rad)+/-0.01	B1+/-0.005	B2+/-0.005	C	D+/-0.01	E+/-0.02	F+/-0.01	G+/-0.016	T+/-0.003
0.375	0.205	0.283	2.938	0.290	0.750	0.500	1.500	0.030

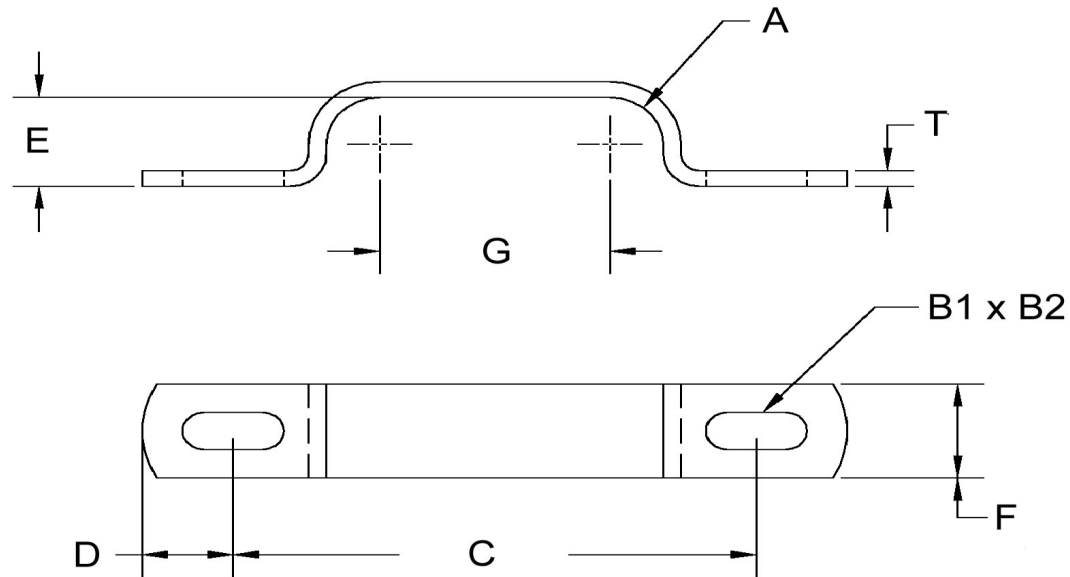

Dimensions in Inches



SEASTROM MANUFACTURING CO., INC.
 456 SEASTROM STREET
 TWIN FALLS, IDAHO 83301
 (208) 737-4300 FAX (208) 734-7222

ALL INFORMATION
 COPYRIGHTED BY
 SEASTROM MFG. ©

PART NO.:	5310-20
PART NAME:	Clamps, Retaining
MATERIAL:	Cold Rolled Steel
HEAT TREAT:	Please refer to Material & Finish Specifications in Engineering Resources
FINISH:	None