

D1+/-0.015	D2+/-0.015	L+/-0.01	T (Stk)+/-0.002	H (Max)	W (Base Max)	E+/-0.003
0.187	0.350	0.234	0.013	0.422	0.391	0.116

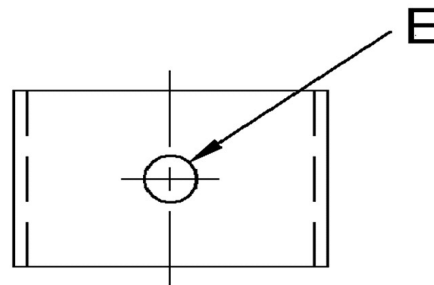

ALL DIMENSIONS ARE TO BE MEASURED WITH THE SPRING CLIP SECURED TO A FLAT SURFACE AND A COMPONENT OF THE NOMINAL DIAMETER IN PLACE.

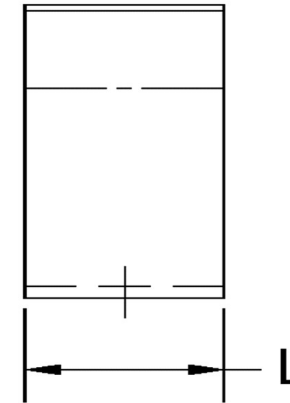
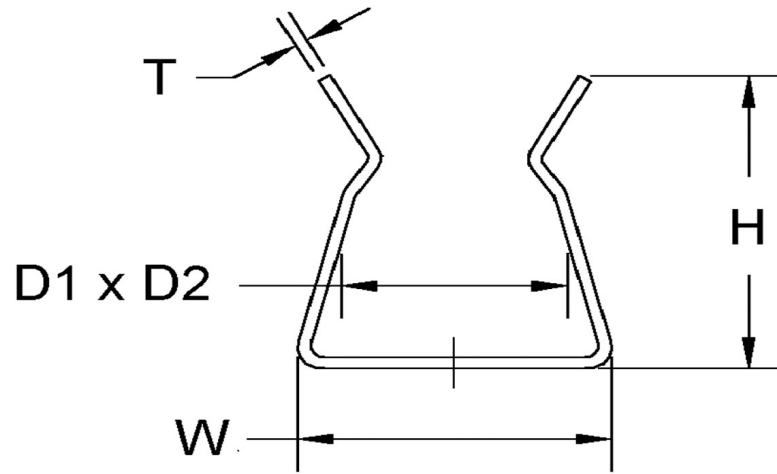

SEASTROM MANUFACTURING CO., INC.
456 SEASTROM STREET
TWIN FALLS, IDAHO 83301
(208) 737-4300 FAX (208) 734-7222

ALL INFORMATION
COPYRIGHTED BY
SEASTROM MFG. ©

PART NO.: 4505-18X35-23-1-T

PART NAME: Spring Clips 14

MATERIAL: Beryllium Copper

HEAT TREAT: Please refer to Material & Finish Specifications in Engineering Resources

FINISH: Bright Tin (All Dimensions Are Prior To Plating)

Dimensions in Inches