

D1+/-0.015	D2+/-0.015	L+/-0.01	T (Stk)+/-0.002	H (Max)	W (Base Max)	E+/-0.003
0.187	0.350	0.216	0.013	0.422	0.391	0.116

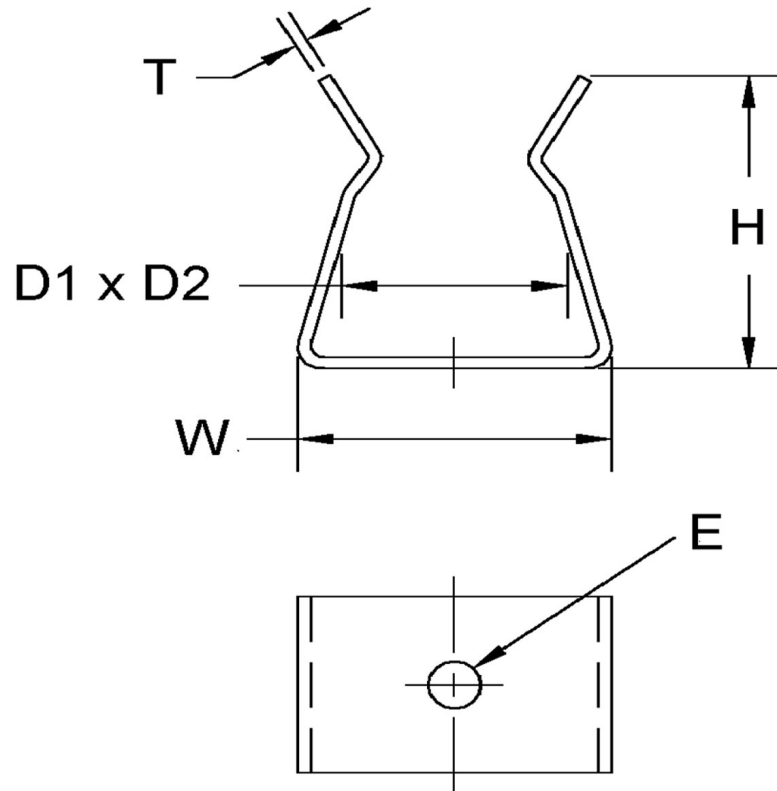

ALL DIMENSIONS ARE TO BE MEASURED WITH THE SPRING CLIP SECURED TO A FLAT SURFACE AND A COMPONENT OF THE NOMINAL DIAMETER IN PLACE.



SEASTROM MANUFACTURING CO., INC.
 456 SEASTROM STREET
 TWIN FALLS, IDAHO 83301
 (208) 737-4300 FAX (208) 734-7222

ALL INFORMATION
 COPYRIGHTED BY
 SEASTROM MFG. ©

PART NO.:	4505-18X35-21-1-T
PART NAME:	Spring Clips 14
MATERIAL:	Beryllium Copper
HEAT TREAT:	Please refer to Material & Finish Specifications in Engineering Resources
FINISH:	Bright Tin (All Dimensions Are Prior To Plating)

Dimensions in Inches