

REFERENCE SEASTROM WORKMANSHIP STD. 8.4.1.W2

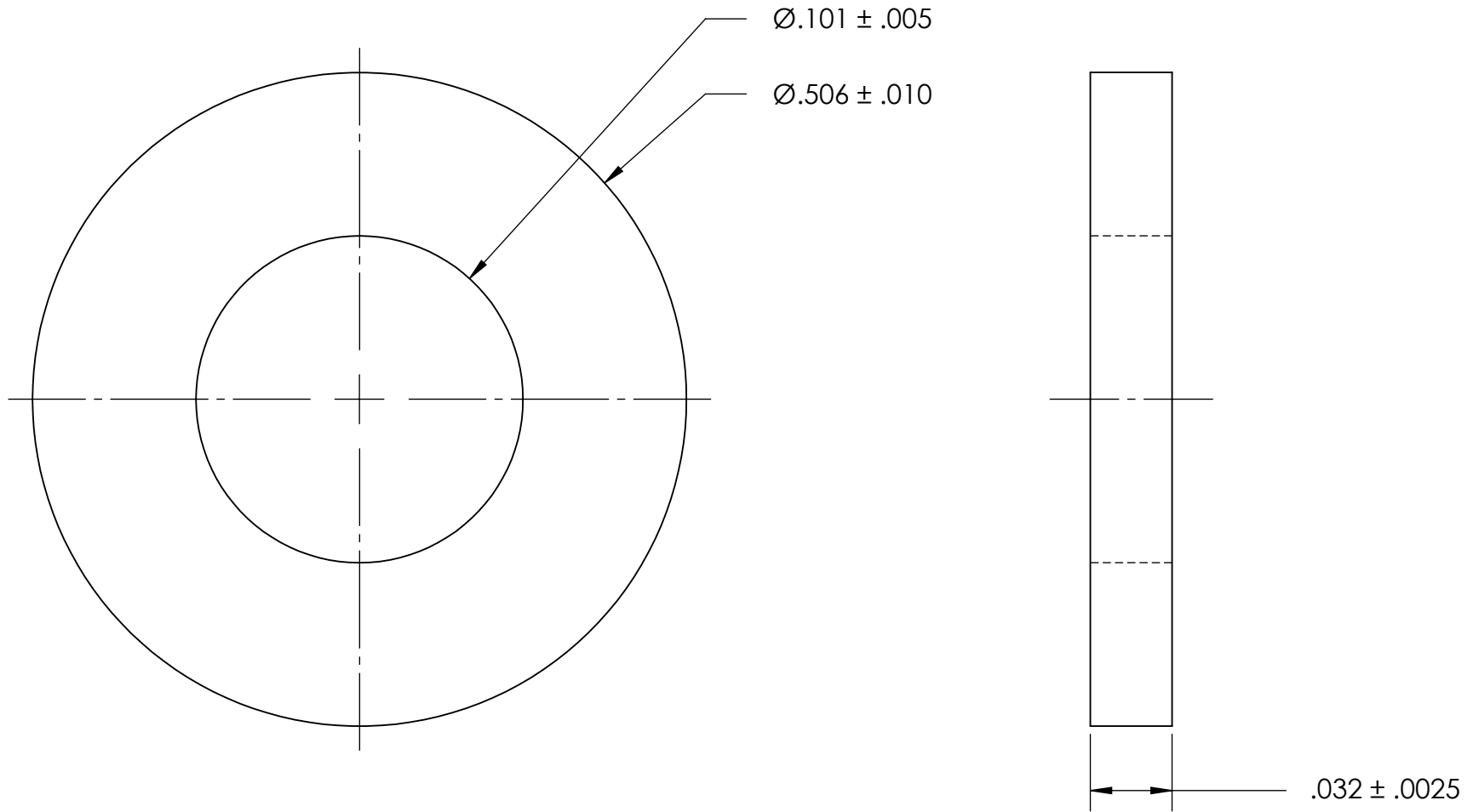

NOTES
1. NONE

PROPRIETARY AND CONFIDENTIAL
THE INFORMATION CONTAINED IN THIS DRAWING IS THE SOLE PROPERTY OF SEASTROM MANUFACTURING. ANY REPRODUCTION IN PART OR AS A WHOLE WITHOUT THE WRITTEN PERMISSION OF SEASTROM MANUFACTURING IS PROHIBITED.

DIMENSIONS ARE IN INCHES TOLERANCES: FRACTIONAL $\pm 1/32$ ANGULAR: MACH $\pm 1/2$ Deg TWO PLACE DECIMAL $\pm .01$ THREE PLACE DECIMAL $\pm .005$	NAME	DATE	SEASTROM MFG		
	DRAWN				
	CHECKED		FLAT ROUND WASHER		
	ENG APPR.				
	MFG APPR.				
MATERIAL ALUMINUM	Q.A.		SIZE	DWG. NO.	REV.
FINISH SEE NOTE 1	COMMENTS:		A	5712-10-32	-
DRAWING IS NOT TO SCALE			SHEET 1 OF 1		