

REFERENCE SEASTROM WORKMANSHIP STD. 8.4.1.W2

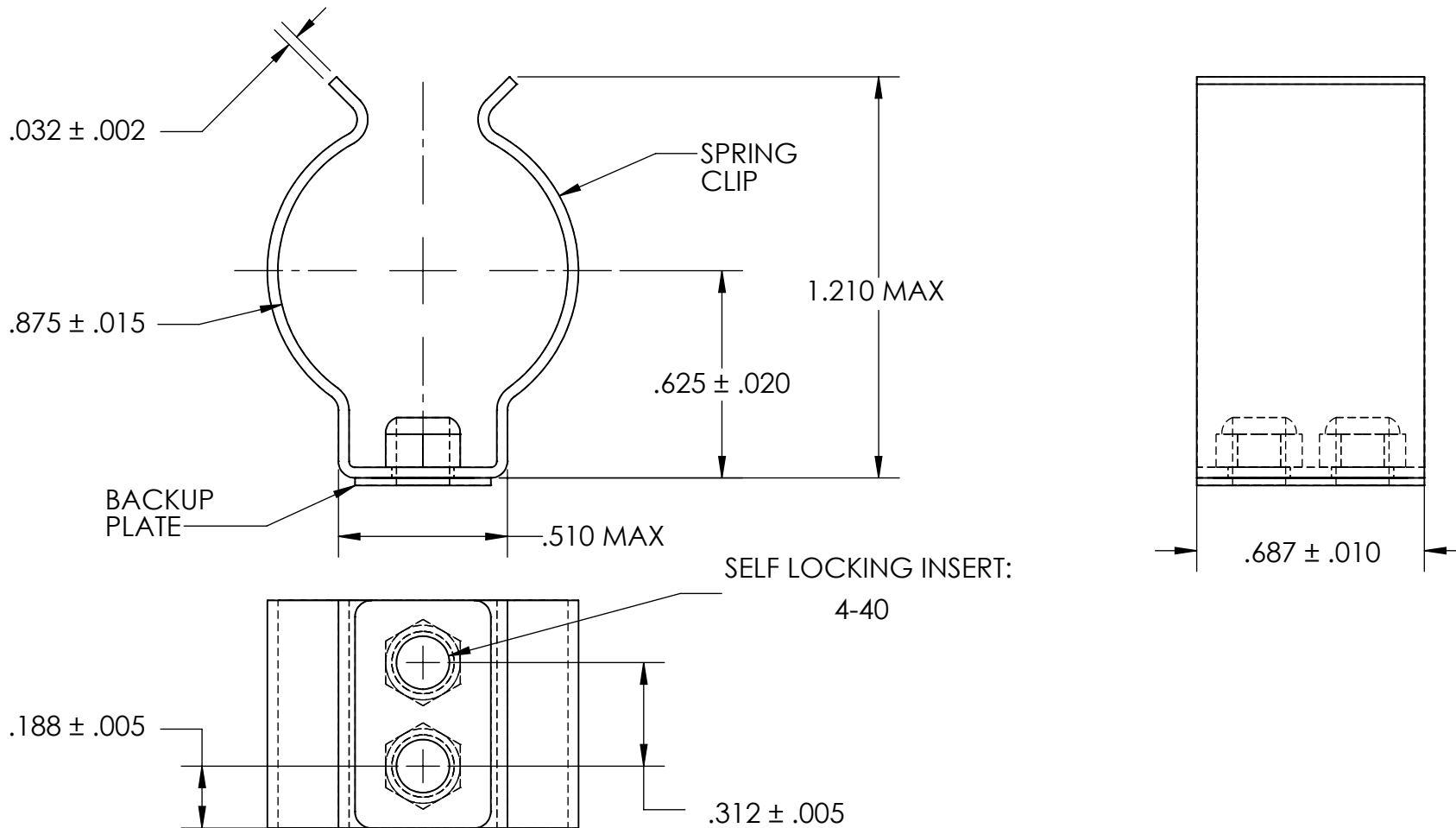

NOTES

1. SPRING STEEL, ANNEALED
2. QUENCH & TEMPER 80-83 HR15N (SPRING CLIP ONLY)
3. BRIGHT TIN PLATE PER ASTM B545, CLASS B (SPRING CLIP AND BACKUP PLATE)
4. DIMENSIONS ARE TAKEN WITH THE PART CLAMPED TO A FLAT SURFACE AND A DUMMY COMPONENT IN PLACE.
5. DIMENSIONS APPLY PRIOR TO PLATING.

PROPRIETARY AND CONFIDENTIAL
 THE INFORMATION CONTAINED IN THIS DRAWING IS THE SOLE PROPERTY OF SEASTROM MANUFACTURING. ANY REPRODUCTION IN PART OR AS A WHOLE WITHOUT THE WRITTEN PERMISSION OF SEASTROM MANUFACTURING IS PROHIBITED.

DIMENSIONS ARE IN INCHES TOLERANCES: FRACTIONAL ± 1/32 ANGULAR: MACH ± 1/2 Deg TWO PLACE DECIMAL ± .01 THREE PLACE DECIMAL ± .005		NAME	DATE	SEASTROM MFG
MATERIAL SEE NOTE 1		DRAWN		
HEAT TREAT SEE NOTE 2		CHECKED		SPRING CLIP
FINISH SEE NOTE 3		ENG APPR.		
		MFG APPR.		
		Q.A.		
		COMMENTS:		
		SIZE	DWG. NO.	REV.
		A	4543-87-68-2-T	-
DRAWING IS NOT TO SCALE			SHEET 1 OF 1	